

	5	4	3	2	1
H	1710-2115	1900-2350	2090-2585	2280-2820	2470-3055
A	112°	126°	140°	154°	168°
B	96°	108°	120°	132°	144°

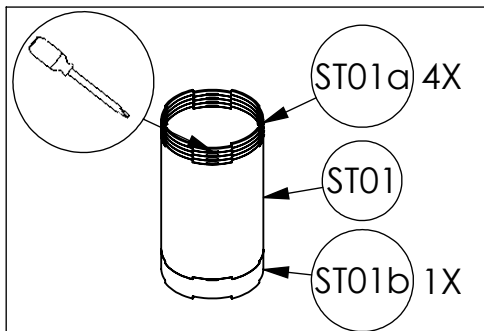

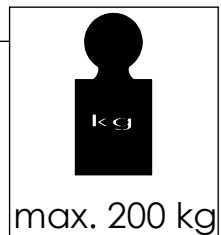

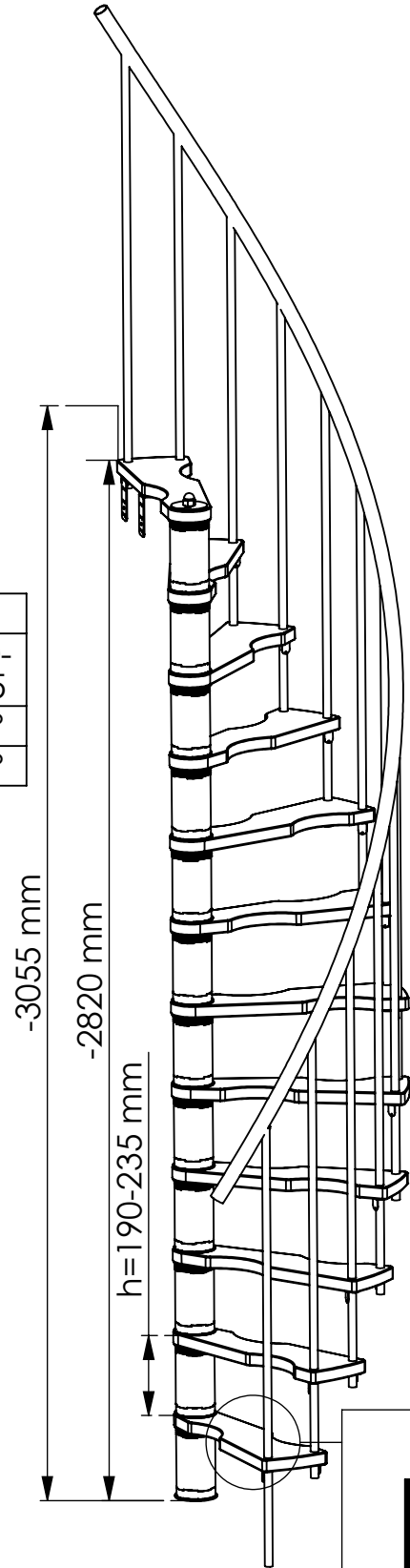







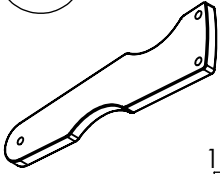
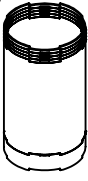
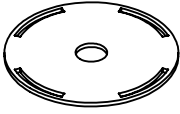

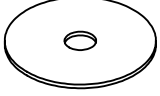
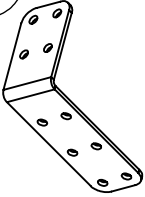

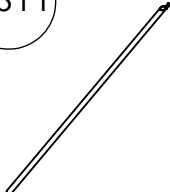
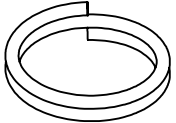
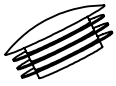
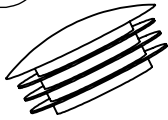
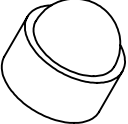
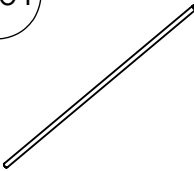

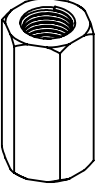

h	ST01a	ST01b
190 mm	0x	0x
195 mm	1x	0x
200 mm	2x	0x
205 mm	3x	0x
210 mm	4x	0x
215 mm	0x	1x
220 mm	1x	1x
225 mm	2x	1x
230 mm	3x	1x
235 mm	4x	1x

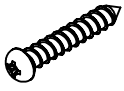

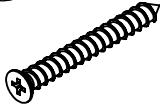
1

Wir gratulieren Ihnen zum Kauf unserer **Treppe Philadelphia!**

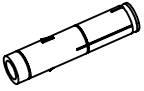
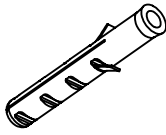

<p>HS10 a..120 b..140</p>  <p>12x</p>	<p>ST01</p>  <p>12x</p> <p>∅ 108x200 mm</p>	<p>ST02</p>  <p>23x</p>	<p>ST03</p>  <p>1x</p>	<p>ST06u</p>  <p>1x</p> <p>∅ 100 x 3 mm</p>
<p>ST09</p>  <p>2x</p>	<p>ST11</p>  <p>24x</p>	<p>ST14</p>  <p>1x</p>	<p>GS11</p>  <p>13x</p> <p>∅ 22x2x1260 mm</p>	<p>G01</p>  <p>1x</p> <p>∅ 40x3x6000mm</p>
<p>KS01</p>  <p>12x</p> <p>∅ 22 mm</p>	<p>KS02</p>  <p>2x</p> <p>∅ 40 mm</p>	<p>KS04</p>  <p>1x</p> <p>M20</p>	<p>NT01</p>  <p>3x</p> <p>M20x1000 mm</p>	<p>NT02</p>  <p>6x</p> <p>M20 DIN 934</p>
<p>NT04</p>  <p>2x</p> <p>M20 DIN 6334</p>	<p>NT05</p>  <p>4x</p> <p>M8x50 mm</p>	<p>NT06</p>  <p>48x</p> <p>∅ 5 x 30 mm</p>	<p>NT07</p>  <p>24x</p> <p>4,2 x 19mm</p>	<p>NT08</p>  <p>1x</p> <p>∅ 4 x 50 mm</p>
<p>NT09</p>  <p>8x</p> <p>6 x 30mm</p>	<p>NT10</p>  <p>12x</p> <p>6 x 50mm</p>	<p>NT11</p>  <p>26x</p> <p>∅ 4x25mm</p>	<p>NT30</p>  <p>1x</p> <p>M5 x 6 mm</p>	<p>NT31</p>  <p>1x</p> <p>M5 DIN 562</p>
<p>D01</p>  <p>4x</p> <p>∅ 12 mm</p>	<p>D02</p>  <p>12x</p> <p>∅ 8mm</p>	<p>D03</p>  <p>1x</p> <p>∅ 6mm</p>		

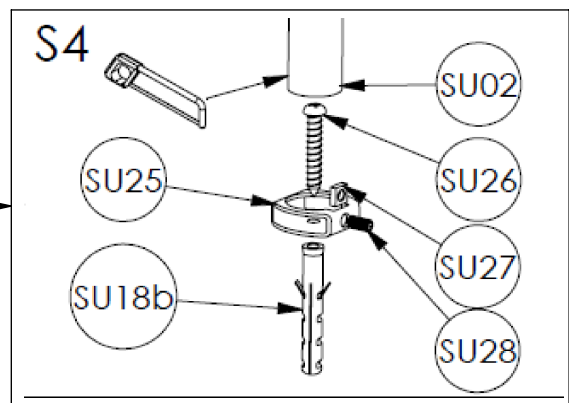
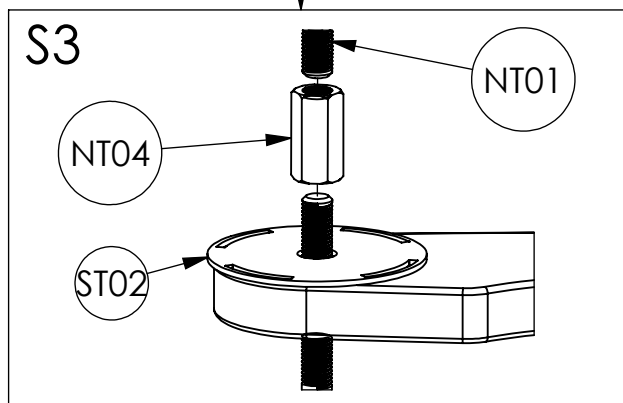
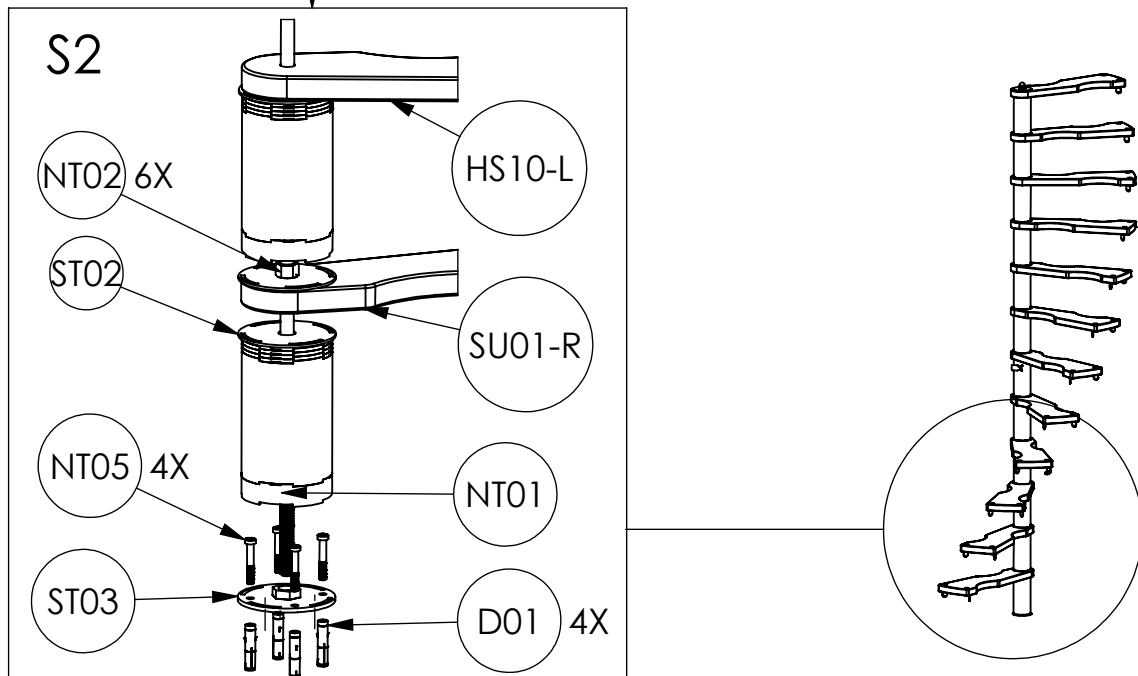
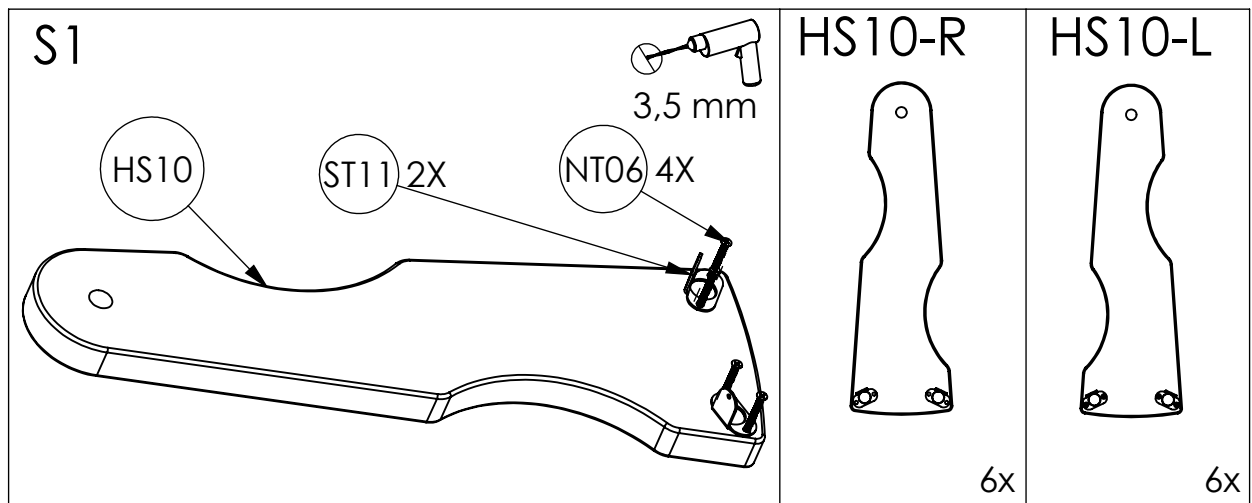

3

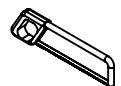
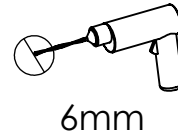
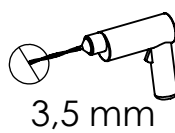
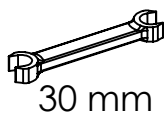
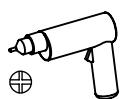
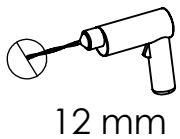

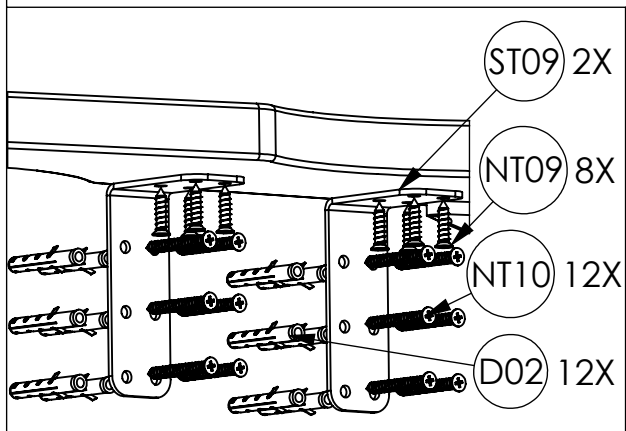
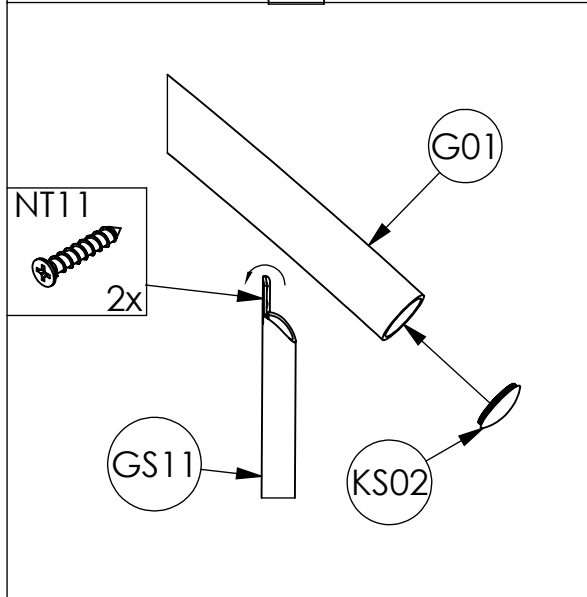
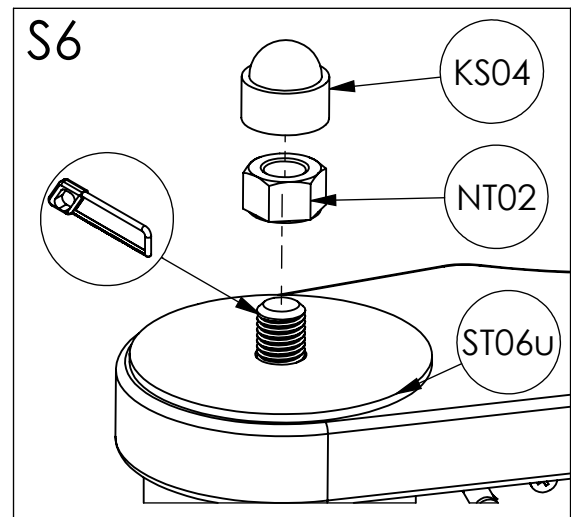
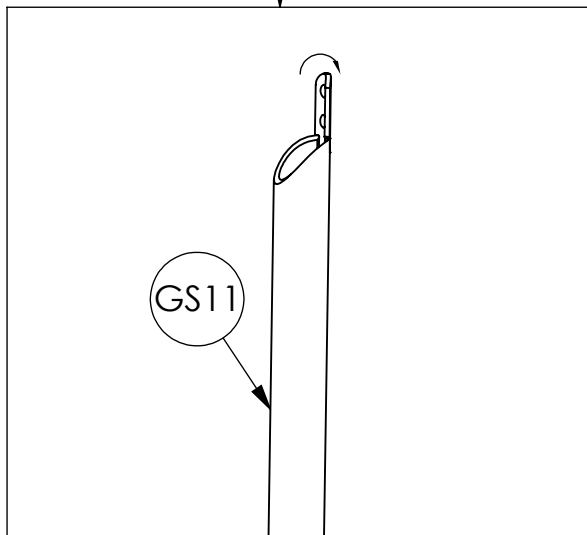
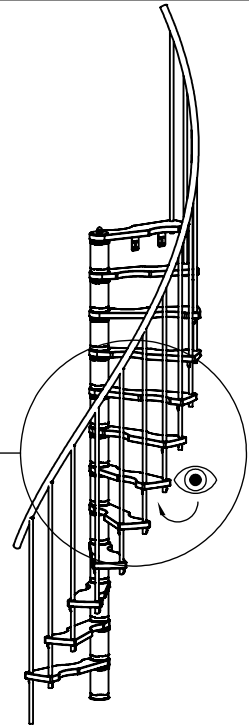
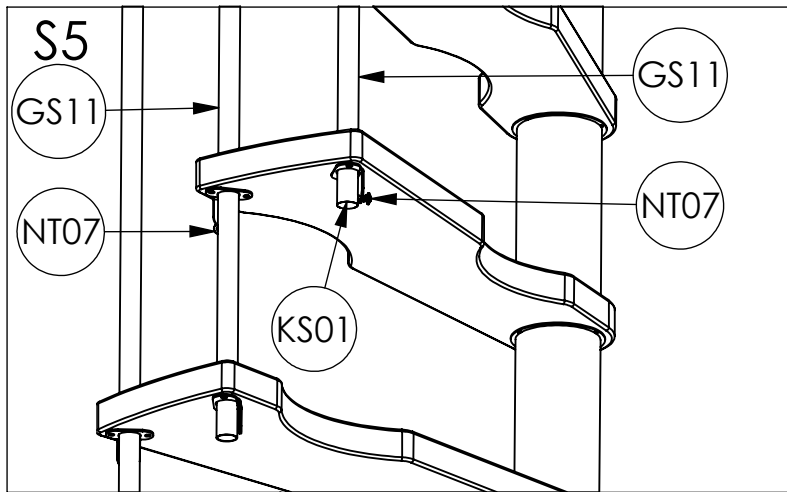

4

